

On the blowup, nonuniqueness, and stochastic explosion of PDE

Tuan Pham

Oregon State University

January 10, 2020

Diffusion equation – Probabilistic representation

In $\mathbb{R}^d \times (0, \infty)$, consider the initial-value problem

$$\begin{cases} \partial_t u - \frac{1}{2} \Delta u = 0, \\ u(x, 0) = u_0(x). \end{cases}$$

Classical solution:

$$u(x, t) = \int_{\mathbb{R}^d} \underbrace{\frac{1}{(2\pi t)^{d/2}} \exp\left(-\frac{|y-x|^2}{2t}\right)}_{\Phi(y-x, t)} u_0(y) dy.$$

Diffusion equation – Probabilistic representation

In $\mathbb{R}^d \times (0, \infty)$, consider the initial-value problem

$$\begin{cases} \partial_t u - \frac{1}{2} \Delta u = 0, \\ u(x, 0) = u_0(x). \end{cases}$$

Classical solution:

$$u(x, t) = \int_{\mathbb{R}^d} \underbrace{\frac{1}{(2\pi t)^{d/2}} \exp\left(-\frac{|y-x|^2}{2t}\right)}_{\Phi(y-x, t)} u_0(y) dy.$$

Observe: $\Phi(\cdot - x, t)$ is the p.d.f of an $\mathcal{N}(x, t I_d)$ -random variable in \mathbb{R}^d , e.g. Brownian motion B_t^x .

$$u(x, t) = \mathbb{E}[u_0(B_t^x)].$$

Diffusion equation – Probabilistic representation

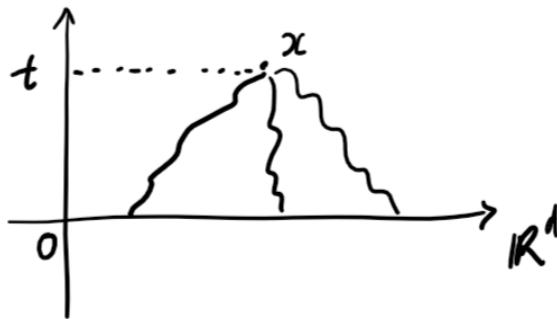

“Stochastic characteristic curves”

$$\begin{cases} \partial_t u - \frac{1}{2} \Delta u &= -K(x)u, \\ u(x, 0) &= u_0(x). \end{cases}$$

Feynman-Kac formula (1940s):

$$u(x, t) = \mathbb{E} \left[u_0(B_t^x) \exp \left(- \int_0^t K(B_s^x) ds \right) \right].$$

The problem can be formulated and generalized (with drift term ∇u and forcing f) by Itô calculus (1950s).

KPP-Fisher equation

In $\mathbb{R} \times (0, \infty)$, consider the equation (Kolmogorov-Petrovskii-Piskunov (KPP), Fisher, 1937):

$$\begin{cases} u_t - \frac{1}{2}u_{xx} &= u^2 - u, \\ u(x, 0) &= u_0(x). \end{cases}$$

With $\Psi = e^{-t}\Phi$,

$$u(x, t) = \int_{\mathbb{R}} \Psi(x - y, t) u_0(y) dy + \int_0^t \int_{\mathbb{R}} \Psi(x - y, s) u^2(y, t - s) dy ds.$$

Noting that Ψ is a p.d.f on $\mathbb{R} \times (0, \infty)$, McKean (1975) gave a probabilistic description of this equation by branching process.

$T \sim \text{Exp}(1)$: holding time (the clock).

$$u(x, t) = \mathbb{E} [u_0(B_t^x) \mathbb{1}_{T > t}] + \mathbb{E} [u^2(B_T^x, t - T) \mathbb{1}_{T \leq t}]$$

In other words, $u(x, t) = \mathbb{E}[\mathbf{X}(x, t)]$ where

$$\mathbf{X}(x, t) = \begin{cases} u_0(B_t^x) & \text{if } T > t, \\ \mathbf{X}^{(1)}(B_T^x, t - T) \mathbf{X}^{(2)}(B_T^x, t - T) & \text{if } T \leq t. \end{cases}$$

Here $\mathbf{X}^{(1)}$ and $\mathbf{X}^{(2)}$ are i.i.d copies of \mathbf{X} and are independent of T .

KPP-Fisher equation – Branching process

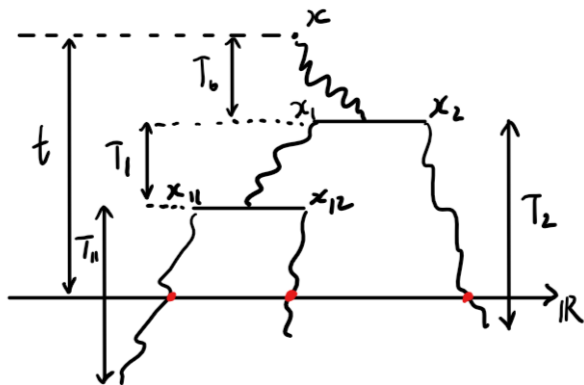

$$\mathbf{X}(x, t) = u_0(B_{t-T_0-T_1}^{x_{11}})u_0(B_{t-T_0-T_1}^{x_{12}})u_0(B_{t-T_0}^{x_2}).$$

Diffusion-reaction equation – Fourier domain – Ex. 1

The heat operator $\partial_t - \Delta$ naturally induces a clock in the Fourier domain. For example,

$$u_t - u_{xx} = bu, \quad u(x, 0) = u_0(x).$$

In Fourier domain,

$$\hat{u}(\xi, t) = e^{-t\xi^2} \hat{u}_0(\xi) + \int_0^t e^{-s\xi^2} b \hat{u}(\xi, t-s) ds.$$

Put $\chi = \xi^2 \hat{u}$. Then

$$\chi(\xi, t) = e^{-t\xi^2} \chi_0(\xi) + \int_0^t \underbrace{\xi^2 e^{-s\xi^2}}_{\text{p.d.f}} \frac{b}{\xi^2} \chi(\xi, t-s) ds.$$

Diffusion-reaction equation – Fourier domain – Ex. 1

$$\chi(\xi, t) = \mathbb{E}[\mathbf{X}(\xi, t)]$$

where

$$\mathbf{X}(\xi, t) = \begin{cases} \chi_0(\xi) & \text{if } T > t, \\ \frac{b}{\xi^2} \mathbf{X}(\xi, t - T) & \text{if } T \leq t. \end{cases}$$

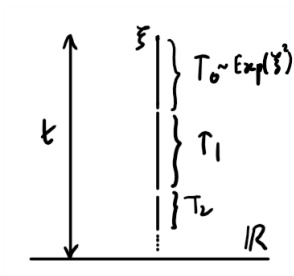

$$\mathbf{X}(\xi, t) = \left(\frac{b}{\xi^2}\right)^{N_t} \chi_0(\xi), \quad N_t = \inf \{n : T_0 + T_1 + \dots + T_n > t\}$$

$$u_t - u_{xx} = (\cos x)u, \quad u(x, 0) = u_0(x).$$

$$\hat{u}(\xi, t) = \hat{u}_0(\xi)e^{-t\xi^2} + \frac{c}{2} \int_0^t \xi^2 e^{-s\xi^2} \left(\frac{\hat{u}(\xi - 1, t - s)}{\xi^2} + \frac{\hat{u}(\xi + 1, t - s)}{\xi^2} \right) ds$$

Diffusion-reaction equation – Fourier domain – Ex. 2

$$u_t - u_{xx} = (\cos x)u, \quad u(x, 0) = u_0(x).$$

$$\hat{u}(\xi, t) = \hat{u}_0(\xi)e^{-t\xi^2} + \frac{c}{2} \int_0^t \xi^2 e^{-s\xi^2} \left(\frac{\hat{u}(\xi - 1, t - s)}{\xi^2} + \frac{\hat{u}(\xi + 1, t - s)}{\xi^2} \right) ds$$

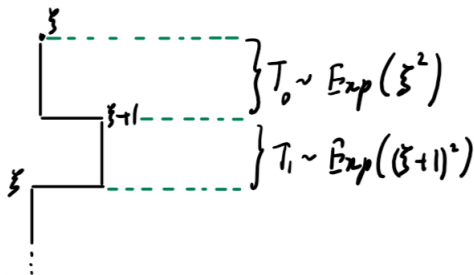

$$\mathbf{X}(\xi, t) = \begin{cases} \chi_0(\xi) & \text{if } T > t, \\ \frac{c}{\xi^2} \mathbf{X}(W, t - T) & \text{if } T \leq t. \end{cases}$$

$$\mathbb{P}_\xi(W = \xi - 1) = \mathbb{P}_\xi(W = \xi + 1) = 1/2.$$

Diffusion-reaction equation – Fourier domain – Ex. 3

$$u_t - \frac{1}{2}u_{xx} = u^2 - u, \quad u(x, 0) = u_0(x).$$

Fourier domain:

$$\hat{u}_t + \underbrace{\left(1 + \frac{1}{2}|\xi|^2\right)}_{\lambda(\xi)} \hat{u} = \hat{u}^2.$$

$$\hat{u}(\xi, t) = e^{-\lambda(\xi)t} \hat{u}_0 + c \int_0^t e^{-\lambda(\xi)s} \hat{u}(\eta, t-s) \hat{u}(\xi - \eta, t-s) d\eta ds$$

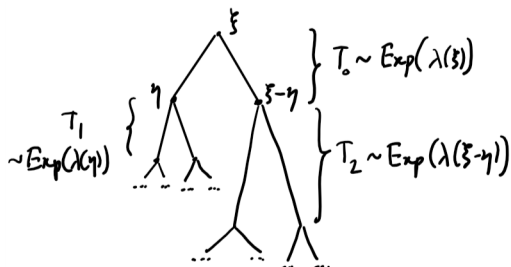

Navier-Stokes equations

$$(NSE) : \begin{cases} \partial_t u - \Delta u + u \cdot \nabla u + \nabla p = 0 & \text{in } \mathbb{R}^d \times (0, \infty), \\ \operatorname{div} u = 0 & \text{in } \mathbb{R}^d \times (0, \infty), \\ u(\cdot, 0) = u_0 & \text{in } \mathbb{R}^d. \end{cases}$$

Integro-differential equation:

$$u(x, t) = e^{\Delta t} u_0 - \int_0^t e^{\Delta s} \mathbf{P} \operatorname{div}[u(t-s) \otimes u(t-s)] ds.$$

Navier-Stokes equations

$$(NSE) : \begin{cases} \partial_t u - \Delta u + u \cdot \nabla u + \nabla p = 0 & \text{in } \mathbb{R}^d \times (0, \infty), \\ \operatorname{div} u = 0 & \text{in } \mathbb{R}^d \times (0, \infty), \\ u(\cdot, 0) = u_0 & \text{in } \mathbb{R}^d. \end{cases}$$

Integro-differential equation:

$$u(x, t) = e^{\Delta t} u_0 - \int_0^t e^{\Delta s} \mathbf{P} \operatorname{div}[u(t-s) \otimes u(t-s)] ds.$$

In Fourier domain:

$$\hat{u}(\xi, t) = e^{-|\xi|^2 t} \hat{u}_0(\xi) + c_0 \int_0^t e^{-|\xi|^2 s} |\xi| \int_{\mathbb{R}^d} \hat{u}(\eta, t-s) \odot_{\xi} \hat{u}(\xi - \eta, t-s) d\eta ds$$

where $a \odot_{\xi} b = -i(e_{\xi} \cdot b)(\pi_{\xi^{\perp}} a)$.

Fourier-transformed Navier-Stokes equations (FNS)

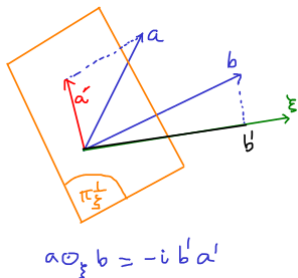

Normalization to (FNS): LJS 1997, Bhattacharya et al 2003.

$$\begin{aligned} \chi(\xi, t) &= e^{-t|\xi|^2} \chi_0(\xi) \\ &+ \int_0^t e^{-s|\xi|^2} |\xi|^2 \int_{\mathbb{R}^d} \chi(\eta, t-s) \odot_{\xi} \chi(\xi-\eta, t-s) H(\eta|\xi) d\eta ds \end{aligned}$$

where $\chi = c_0 \hat{u}/h$ and $H(\eta|\xi) = \frac{h(\eta)h(\xi-\eta)}{|\xi|h(\xi)}$.

h : majorizing kernel, i.e. $h * h = |\xi|h$.

Cascade structure of FNS

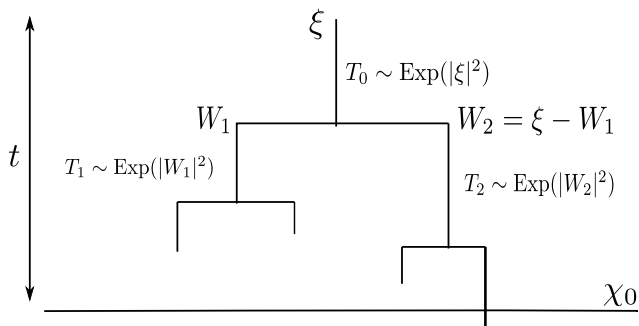

Define a stochastic multiplicative functional recursively as

$$\mathbf{x}_{\text{FNS}}(\xi, t) = \begin{cases} \chi_0(\xi) & \text{if } T_0 > t, \\ \mathbf{x}_{\text{FNS}}^{(1)}(W_1, t - T_0) \odot_{\xi} \mathbf{x}_{\text{FNS}}^{(2)}(\xi - W_1, t - T_0) & \text{if } T_0 \leq t. \end{cases}$$

An example of \mathbf{X}_{FNS}

Consider the following event:

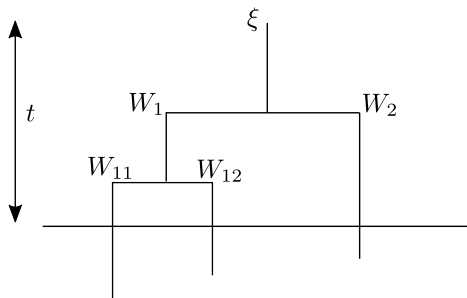

On this event,

$$\mathbf{X}_{\text{FNS}}(\xi, t) = (\chi_0(W_{11}) \odot_{W_1} \chi_0(W_{12})) \odot_{\xi} \chi_0(W_2).$$

Three ingredients: clocks, branching process, product.

Cascade structure = clocks + branching process.

Stochastic cascade solutions – Two issues

We referred to solutions given by the expectation of a multiplicative stochastic functional \mathbf{X} as *stochastic cascade solutions*.

Cascade structure = clocks + branching process.

There are two potential issues with this construction:

- Stochastic explosion: the branching process may never stop, making \mathbf{X} not well-defined.
- Existence of the expectation: it may happen that $\mathbb{E}|\mathbf{X}| = \infty$.

Stochastic cascade solutions – Two issues

We referred to solutions given by the expectation of a multiplicative stochastic functional \mathbf{X} as *stochastic cascade solutions*.

Cascade structure = clocks + branching process.

There are two potential issues with this construction:

- Stochastic explosion: the branching process may never stop, making \mathbf{X} not well-defined.
- Existence of the expectation: it may happen that $\mathbb{E}|\mathbf{X}| = \infty$.

Existence of expectation \longleftrightarrow smallness of initial condition.

Stochastic explosion: (1) *Can it happen?* (2) *Any connection with non-uniqueness?*

Explosion

$$S_n = \min_{|\nu|=n} \sum_{j=0}^n T_{\nu|j}, \quad S = \lim_{n \rightarrow \infty} S_n = \sup_{n \in \mathbb{N}} S_n$$

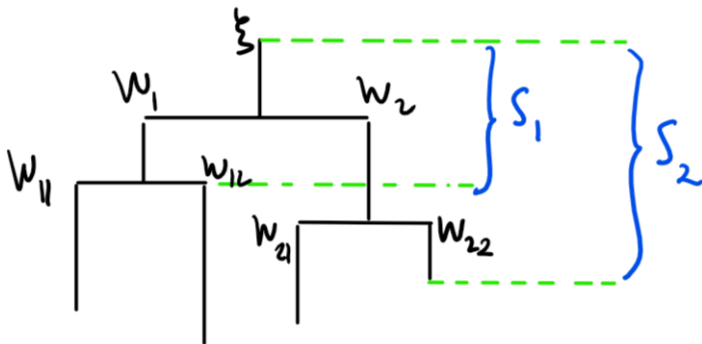

Explosion event: $\{S < \infty\}$.

Non-explosion event : $\{S = \infty\}$.

Examples of non-explosion

$$u_t - u_{xx} = u^2 - u, \quad u(x, 0) = u_0(x).$$

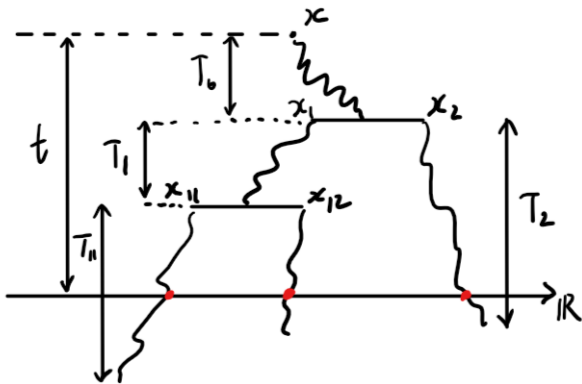

Examples of non-explosion

$$u_t - u_{xx} = bu, \quad u(x, 0) = u_0(x).$$

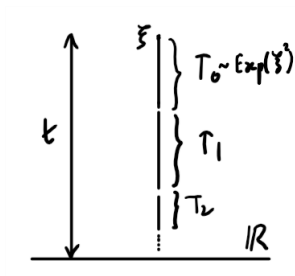

Example of non-explosion

$$u_t - u_{xx} = (\cos x)u, \quad u(x, 0) = u_0(x).$$

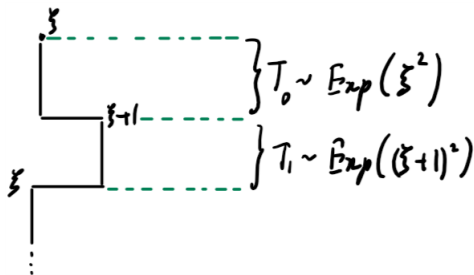

$$\mathbb{P}_\xi(W = \xi - 1) = \mathbb{P}_\xi(W = \xi + 1) = 1/2.$$

Example of non-explosion

$$u_t - u_{xx} = (\cos x)u, \quad u(x, 0) = u_0(x).$$

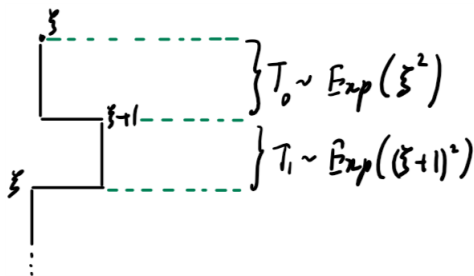

$$\mathbb{P}_\xi(W = \xi - 1) = \mathbb{P}_\xi(W = \xi + 1) = 1/2.$$

$$\sum_{n=1}^{\infty} T_{\nu|n} = \sum_{n=1}^{\infty} \frac{\bar{T}_{\nu|n}}{|W_{\nu|n}|^2} \geq \sum_{k=1}^{\infty} \frac{\bar{T}_{\nu_k}}{\xi^2} = \frac{1}{\xi^2} \sum_{k=1}^{\infty} \bar{T}_{\nu_k} = \infty \quad \text{a.s.}$$

Branching process may never stop, potentially making \mathbf{X}_{FNS} not well-defined.

- Property of cascade structure, not of product.
- Depending on the majorizing kernel h .
- 3D self-similar cascade $h_{\text{dilog}}(\xi) = C|\xi|^{-2}$: stochastic explosion a.s. (Dascaliuc, Pham, Thomann, Waymire 2019)
- 3D Bessel cascade $h_b(\xi) = C|\xi|^{-1}e^{-|\xi|}$: non-explosive a.s. (Orum, Pham 2019)

Stochastic explosion of NSE

Explosion happens a.s. for the self-similar cascade, how can we define a stochastic cascade solution and is it unique?

Stochastic explosion of NSE

Explosion happens a.s. for the self-similar cascade, how can we define a stochastic cascade solution and is it unique?

Introducing a *ground state*:

$$\mathbf{X}_0(\xi, t) \equiv 0,$$
$$\mathbf{X}_n(\xi, t) = \begin{cases} \chi_0(\xi) & \text{if } T_0 > t, \\ \mathbf{X}_{n-1}^{(1)}(W_1, t - T_0) \odot_{\xi} \mathbf{X}_{n-1}^{(2)}(\xi - W_1, t - T_0) & \text{if } T_0 \leq t. \end{cases}$$

Stochastic explosion of NSE

Explosion happens a.s. for the self-similar cascade, how can we define a stochastic cascade solution and is it unique?

Introducing a *ground state*:

$$\begin{aligned} \mathbf{X}_0(\xi, t) &\equiv 0, \\ \mathbf{X}_n(\xi, t) &= \begin{cases} \chi_0(\xi) & \text{if } T_0 > t, \\ \mathbf{X}_{n-1}^{(1)}(W_1, t - T_0) \odot_{\xi} \mathbf{X}_{n-1}^{(2)}(\xi - W_1, t - T_0) & \text{if } T_0 \leq t. \end{cases} \end{aligned}$$

Ignore the product and regard \mathbf{X}_n as a scalar:

$$\begin{aligned} \mathbf{X}_0(\xi, t) &\equiv 0, \\ \mathbf{X}_n(\xi, t) &= \begin{cases} \chi_0(\xi) & \text{if } T_0 > t, \\ \mathbf{X}_{n-1}^{(1)}(W_1, t - T_0) \mathbf{X}_{n-1}^{(2)}(\xi - W_1, t - T_0) & \text{if } T_0 \leq t. \end{cases} \end{aligned}$$

Nonuniqueness (of cheap NSE)

- For $\chi_0 \equiv 1$ and $\mathbf{X}_0 \equiv 1$ then $\mathbf{X}_n = 1$ for all n . Thus, $\chi = \lim \mathbb{E}\mathbf{X}_n = 1$.
- For $\chi_0 \equiv 1$ and $\mathbf{X}_0 \equiv 0$ then $\chi = \lim \mathbb{E}\mathbf{X}_n = \mathbb{P}(S_\xi > t)$, where S_ξ is the shortest branch of the tree rooted at ξ .
- Both of functions χ above solve the equation

$$\begin{aligned}\chi(\xi, t) &= e^{-t|\xi|^2} \chi_0(\xi) \\ &+ \int_0^t e^{-s|\xi|^2} |\xi|^2 \int_{\mathbb{R}^d} \chi(\eta, t-s) \chi(\xi - \eta, t-s) H(\eta|\xi) d\eta ds\end{aligned}$$

- In physical domain: $\partial_t u - \Delta u = \sqrt{-\Delta}(u^2)$ and $u(x, 0) = c/|x|$, called the *cheap NSE* (Montgomery-Smith 2002).

Another toy model: α -Riccati equation

$$u' + u = u^2(\alpha t), \quad u(0) = u_0.$$

$$\mathbf{X}(t) = \begin{cases} u_0 & \text{if } T > t, \\ \mathbf{X}^{(1)}(\alpha(t-T))\mathbf{X}^{(2)}(\alpha(t-T)) & \text{if } T \leq t. \end{cases}$$



$$\mathbb{E}S \leq \mathbb{E} \left(T_0 + \frac{T_1}{\alpha} + \frac{T_{11}}{\alpha^2} + \frac{T_{111}}{\alpha^3} + \dots \right) = \frac{\alpha}{\alpha - 1} < \infty$$

Thank You!